

PENTAX

smc PENTAX-FA INTERCHANGEABLE LENS OPERATING MANUAL

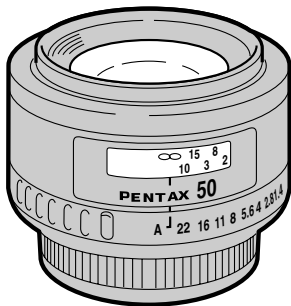

Foreward

Thank you for purchasing the smc PENTAX lens.

This operating manual applies to all of the smc PENTAX FA and FA J lenses.

Please also read your camera's operating manual.

- * In this manual, the "smc PENTAX - FA lens" is referred to as "FA lens" and the "smc PENTAX - FA J lens" as the "FA J lens".
- * Illustrations shown herein may differ from the actual appearance.
- * PENTAX and smc PENTAX are trademarks of HOYA CORPORATION.

Although we have carefully designed these lenses for safe operation, please pay special attention to items marked with the following symbols when using this product.

**WARNING**

This symbol indicates precautions that if not followed, could result in serious injury to the user.

**CAUTION**

This symbol indicates precautions that if not followed, could result in minor or medium injury to the user or damage to the equipment.

 WARNING

- **Never look at the sun through the lens or camera. Serious damage to the retina, or total loss of eyesight may occur.**
- **Wrapping the strap around your neck is dangerous. Make sure that small children do not get the strap caught around their neck. (A strap is supplied only with some large types of lenses)**

 CAUTION

- **Do not leave the lens in direct sunlight without lens caps. Sunrays passing through the lens will be intensified, and should they focus on flammable materials, fire may occur.**

1. Storage and mildew prevention

- Take the lens out of the protective case or camera bag, and store it in a dry, well-ventilated place.
- Avoid storing the lens in a poorly ventilated location such as a closet, wardrobe, drawer, vehicle, or where insect repellent or medicine is kept.
- Avoid storing the lens in areas of high temperature and humidity, where there is a risk of mildew growth.

Store the lens with a desiccant in a dry cabinet, airtight container, or plastic bag. (Leaving a saturated desiccant in the storage container can cause damage to the lens. Be sure to read the instructions that come with the desiccant before use.)

2. The lens is not waterproof. When using the lens in a rain or mist, be careful not to allow it to get wet.
3. Never use any organic solvent such as thinner, alcohol, or benzine, etc. to remove dust on the lens.
4. The lens is a precise optical instrument. Be careful not to let it fall, or subject it to strong shocks or pressure. Use a cushion or similar pad to protect the lens from the vibrations of motorcycles or other vehicles, boats, etc.

5. Avoid subjecting the lens to rapid changes in temperature, otherwise condensation may occur on both the inside and the outside of the lens. Put the lens in a plastic bag or camera bag, and take it out after the lens has reached ambient temperature.
6. When the lens is not attached to the camera body, attach both the provided lens cap and lens mount cap to protect it from dust.
7. Do not leave the camera with the lens cap off attached to a tripod or other rigid camera support. The inner parts of the camera can be damaged by direct sunlight.
8. Have the lens inspected by a dealer every one or two years to maintain its high performance.

PRECAUTIONS AND LENS MAINTENANCE	3
About the smc PENTAX-FA/FA J Lens	7
• About the zoom ring	9
Changing the Lens	10
Finger Point on Limited Lenses	11
Lens Cap	11
Focusing	12
• Autofocusing	12
• Manual focusing	12
• FA* lenses	13
• Setting autofocus	13
• Setting manual focus	13
Setting the Aperture [A (Auto) Lock Switching]	15
• About the Zoom Lens Aperture	16
• Apertures and Click Stops	17
Using the Infrared Index	18
• Zoom Lens Infrared Index	19

Lens Hood	20
• Note:	20
• Compatible Lens Hoods	21
• Attaching a Round Lens Hood	22
• Attaching a Square Lens Hood	23
• Using the Built-in Lens Hood	24
• PL Filter Window	25
Tripod Mount	27
Filters	28
• Filter Cautions	28
• Filter Sizes	28
• Note: Using a Circular Polarizing Filter	29
• Note: Attaching a Specialized Hood	29
Cautions When Using Flash	30
• Compatibility with Built-in Flash	31
Lens Case	32
• Lens Case Compatibility Table	32
Main Specifications	34
STATEMENT OF FCC COMPLIANCE	36

[Single Focal Length Lens]

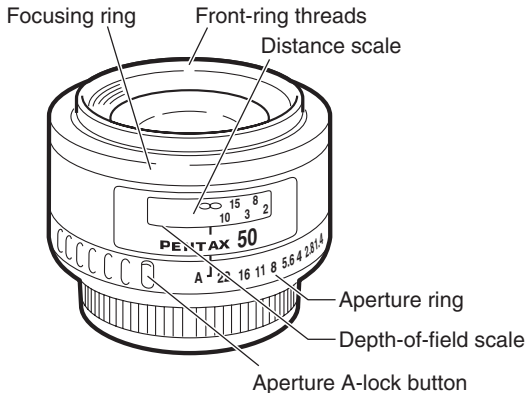

[Zoom Lens]

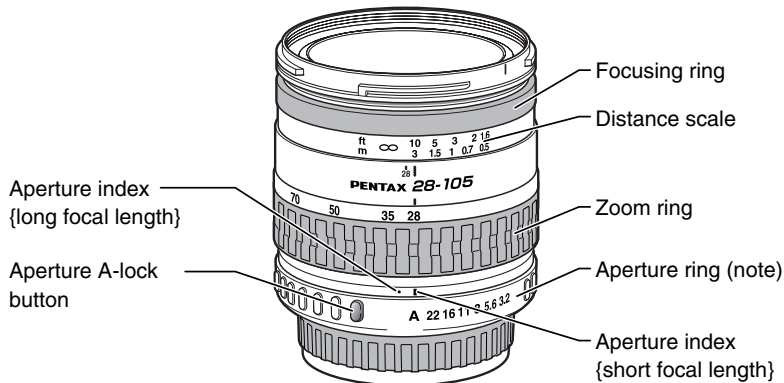

Note: The following lenses do not have an aperture ring: FA J 18-35mm f/4-5.6AL, FA J 28-80mm f/3.5-5.6AL, and FA J 75-300mm f/4.5-5.8AL. The aperture is controlled at the A [Auto] setting. Therefore, the lens is not compatible with cameras and accessories which are not compatible with the A setting.

A zoom lens has two rings: The focusing ring at the front of the lens and the zoom ring behind it. Turn the zoom ring to obtain the desired angle of view (focal distance).

* Whenever you turn the zoom ring to change the angle of view (focal distance), the focus may also change slightly. First turn the zoom ring, then focus.

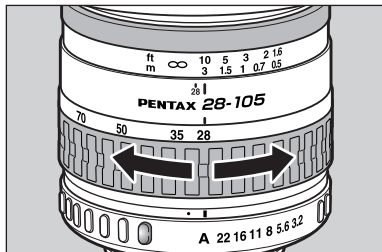

About the zoom ring

Turning the zoom ring to the right gets a [Telephoto] effect, making the subject look larger. Turning it to the left gets a [Wide angle] effect, covering a wider area.

Changing the Lens

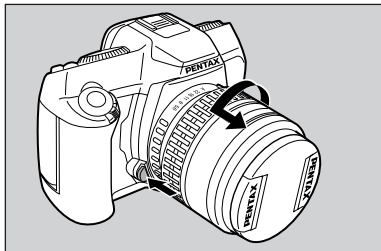
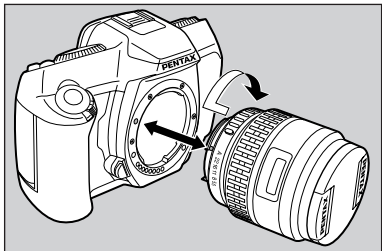

1. Align the mount index red dots on the camera body and lens and attach the lens. Turn the lens clockwise until it locks in place.

2. To detach the lens, hold down the camera's lens unlock button, then turn the lens counterclockwise.

- * When attaching a lens, do not press the camera's lens unlock button. Doing so causes improper lens attachment.
- * After attaching a lens, turn the lens counterclockwise slightly to make sure the lens is locked in place.

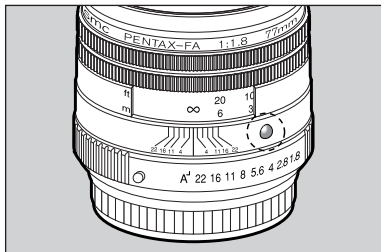

You can easily attach a Limited lens by aligning the finger point on the lens with the camera's lens unlock button.

Limited lenses

FA 31mm f/1.8AL Limited

FA 43mm f/1.9 Limited

FA 77mm f/1.8 Limited

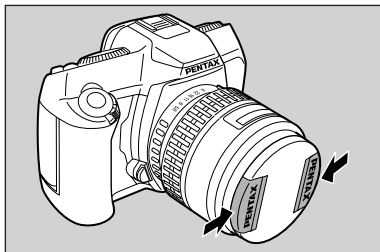

To remove the lens cap, squeeze the tabs as shown in the illustration.

- * When not using a lens, be sure to attach the lens cap.
- * For the FA 43mm f/1.9 Limited lens, attach the lens cap to the hood. The lens cap cannot be attached directly to the front of the lens.

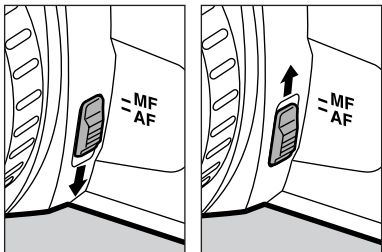

To switch between autofocus and manual focusing, use the camera's focus mode lever. For details, refer to your camera's instruction manual.

- * For FA* lenses, see page 13.
- * For non-autofocus cameras, use manual focusing.

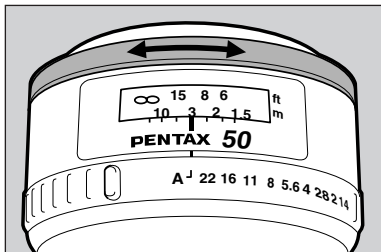

Autofocusing

Press the shutter button halfway to autofocus.

- * During autofocus, the focusing ring rotates so do not touch it.

Manual focusing

Turn the focusing ring as shown in the illustration.

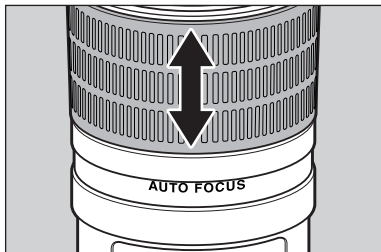

FA* lenses

With FA* lenses, shift the focusing ring forward or back to switch between autofocus and manual focus.

Setting autofocus

Push the focusing ring forward until you can see AUTO FOCUS.

* When the lens is set for autofocus, the focusing ring locks.

Setting manual focus

Pull the focusing ring until AUTO FOCUS is hidden. Turn the focusing ring to focus manually.

- * If your camera has a K_{AF2} mount, you can still switch between auto-focus and manual focus with the lens focusing ring even when the camera has been set to autofocus.
- * If you have a camera (such as the SF-series) having a K_{AF} mount, set both the camera and lens focus mode switch to the same setting. If the camera is set to autofocus [AF single] and the lens is set to manual focus, you cannot take a picture until the camera's focus indicator lights.
- * If you use a camera which does not have autofocus, focus manually.
- * The telephoto lens' focusing ring stops turning at slightly past the ∞ infinity symbol. This is because, the point of focus changes depending on the temperature, and sometimes the focus is achieved beyond the ∞ infinity symbol.
- * Even when focusing at infinity, always look through the viewfinder to make sure the subject is in focus.
- * When the lens is set for manual focus, the focusing ring can continue to turn even past the minimum focusing distance or infinity mark.

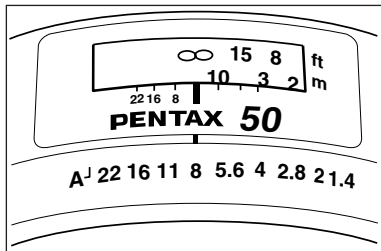
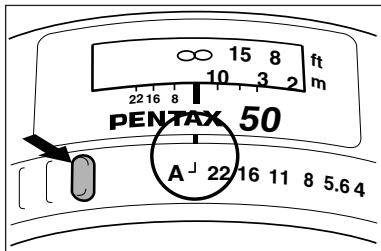

To set the aperture ring to A [Auto], hold down the Aperture A-lock button and align the A index with the white-line index. To set the aperture ring to another setting, hold down the Aperture A-lock button and turn the aperture ring.

* If your camera has a K mount with no lens information contacts, set the aperture ring to any aperture except A.

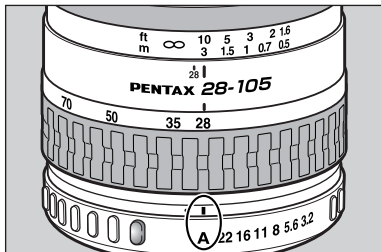

About the Zoom Lens Aperture

Zoom lenses whose maximum aperture varies depending on the focal length have a [Minimum length] aperture index for the shortest focal length and a [Maximum length] aperture index for the longest focal length. To set the aperture to A [Auto], turn the aperture ring to the white [Short focal length index] at the center (regardless of the focal length) as shown in the illustration.

For the longer focal lengths, if you want

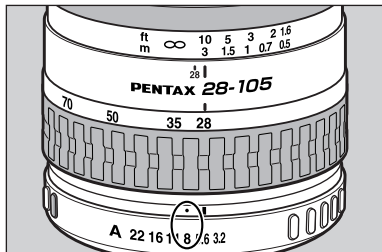

to set an aperture other than A, align the aperture ring with the long focal length's aperture.

For example, with a 28-105mm zoom lens set to 105mm, set the f/8 aperture by aligning the aperture ring's f/8 to the [Long focal length aperture index] mark on the left of the white index.

* When setting the aperture manually at a middle focal length, use the aperture index for the short and long focal lengths as a reference.

Apertures and Click Stops

Certain lenses have a white dot next to the maximum aperture. The white dot indicates a difference of one aperture stop. For example, as shown on the right, the white dot next to $f/2$ indicates $f/2.8$.

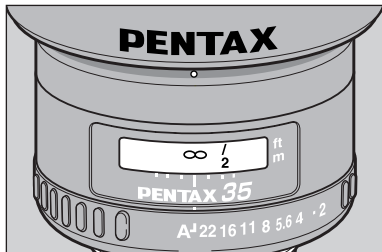

If there is no white dot for a click stop between the f /numbers, the click stop indicates the respective f /number shown below. Also, certain lenses have no intermediate click stop at both ends of the aperture scale due to a lack of space. Do not set the aperture ring to a position where there is no click stop.

• 1.4	• 2	• 2.8	• 4	• 5.6	• 8	• 11	• 16	• 22	• 32	• 45
1.2	1.7	2.4	3.4	4.8	6.7	9.5	13.5	19	26	38

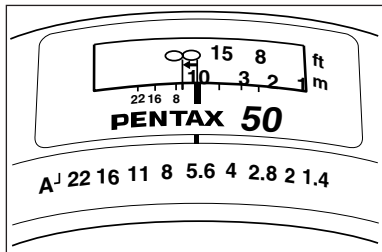
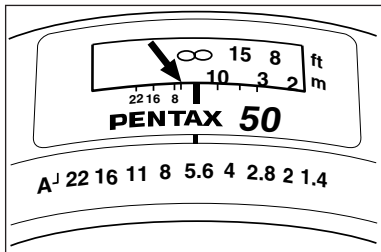

If you use infrared film with an R2 or O2 filter, the point of focus differs from normal shooting (with visible light). This means the point of focus must be corrected.

* Infrared film cannot be used with the MZ-S, MZ-60, and **ist* cameras since these cameras use infrared light to detect film transport operations.

When the subject is in focus in the viewfinder, note the point of focus on the distance scale (shown in the left illustration). Then turn the focusing ring so the respective point of focus on the distance scale is aligned with the infrared index mark, as shown in the right illustration.

- * Before turning the focusing ring, set the focus mode to manual focus.
- * To determine the proper exposure, refer to the film's instruction manual.

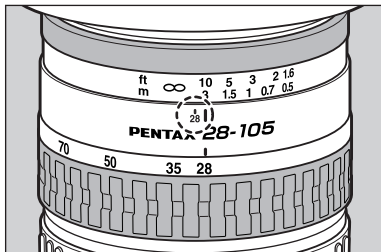

Zoom Lens Infrared Index

With a zoom lens, the focusing correction amount for infrared film shooting varies depending on the focal length.

As shown in the illustration, zoom lenses have an infrared index. Correct the focus with respect to the focal length used.

The lens hood can be round, square, or built-in. Using a lens hood is recommended for preventing internal lens reflections. Suitable hoods are listed on the next page.

Note:

- * Do not use a lens hood if you are using the camera's built-in flash. The hood may obstruct the flash, causing darkened areas in the picture. In the case of the FA 43mm f/1.9 lens, the flash can be used with the hood attached.

Compatible Lens Hoods

Lens	Compatible Hood	Shape	Attachment Method
FA 35mm f/2AL	PH-RBA49	Round	Bayonet
FA 43mm f/1.9Limited	MH-RA49	Round	Screw-on
FA 50mm f/1.4	PH-RA49	Round	Screw-on
	RH-RC49	Round	Screw-on
	PH-SA49	Square	Spring
FA J 18-35mm f/4-5.6AL	PH-RBL67	Round	Bayonet
FA 20-35mm f/4AL	PH-RBA58	Round	Bayonet
FA J 28-80mm f/3.5-5.6AL	PH-RBE58	Round	Bayonet
FA 28-105mm f/3.2-4.5AL (IF)	PH-RBC58	Round	Bayonet
FA J 75-300mm f/4.5-5.8AL	PH-RBF58	Round	Bayonet

PH: Plastic hood, RH: Rubber hood, MH: Metal hood

Attaching a Round Lens Hood Screw-on Type

Screw the hood on to the front of the lens.

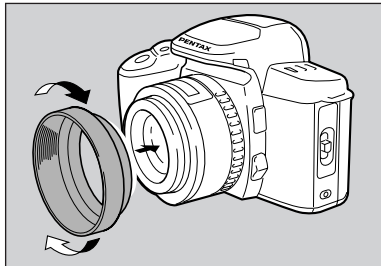

Bayonet Type

Attach the hood to the front of the lens and turn the hood clockwise until it snaps in place.

To detach the lens hood, follow this procedure in reverse.

* When not using the lens hood, you can attach it to the lens in reverse.

Attaching a Square Lens Hood

1. The hood attaches in the same way as a lens cap. While holding down the two knurled tabs, attach the hood to the front of the lens.
2. The square hood should be positioned horizontally on the lens. If it is tilted, vignetting may occur.

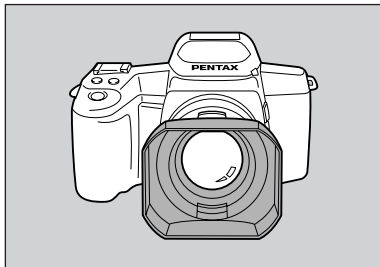
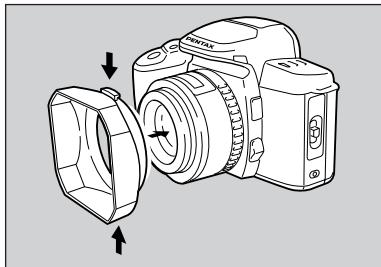

Using the Built-in Lens Hood

To use the built-in lens hood, pull it out from the lens. In the case of the FA* 600mm f/4 lens, the built-in lens hood is threaded. To extend or retract it, turn the hood. For details, see the FA* lens instruction manual.

Lenses with a Built-in Lens Hood

FA 31mm f/1.8AL Limited

FA 77mm f/1.8 Limited

FA* 600mm f/4ED (IF)

- * Extending the FA 77mm f/1.8's lens hood does not obstruct the camera's built-in flash.

PL Filter Window

Certain hoods also have a PL filter window. This enables you to easily rotate any polarizing or circular polarizing filter attached to the lens.

Lenses with a PL filter window

- FA 35mm f/2AL
- FA J18-35mm f/4-5.6AL

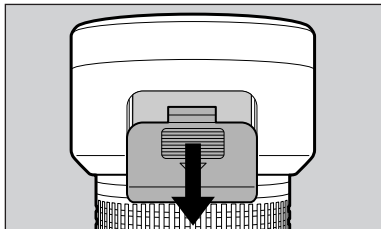

Using the PL filter window

1. Remove the PL filter window cap by sliding it downward, as shown by the arrow.

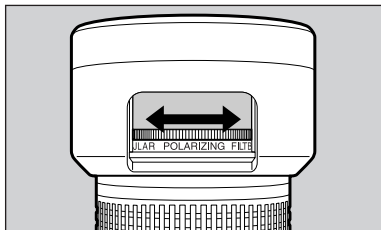

2. From the PL filter window, turn the polarizing or circular polarizing filter.

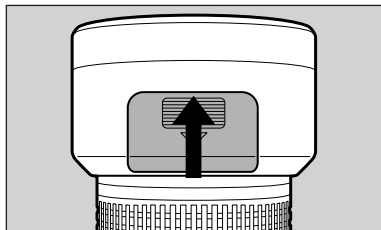

3. Reattach the PL filter window cap.
* Before shooting, be sure the cap has been reattached so that the hood can provide the maximum effect.

The FA* 600mm f/4 lens has a tripod mount so you can mount the lens on a tripod.

Switching between horizontal and vertical shooting

Loosen the lens orientation lock screw and turn the lens by 90° left or right. Then tighten the lens orientation lock screw.

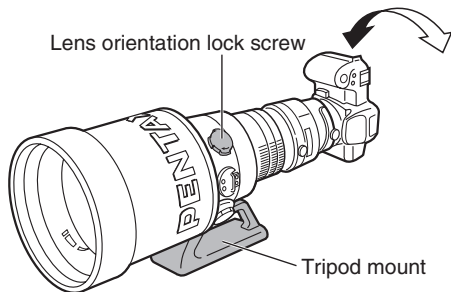

The tripod mount can also be detached. For instructions, see the FA* lens instruction manual.

Select the filter matching the lens filter size, then screw it onto the front of the lens.

- * The FA* 600mm f/4ED (IF) lens has a filter holder in the rear to hold the 43mm filter provided with the lens. For details, see the FA* lens instruction manual.

Filter Cautions

When attached to the lens, the filter becomes part of the lens optics. Therefore, handle it in the same way as the lens. Keep it clean from dust, scratches, smudges, etc. Except for a circular polarizing filter, avoid attaching more than one filter to the lens. Using multiple filters is not effective.

Filter Sizes

Lens	Size
FA 31mm f/1.8AL Limited	58mm
FA 35mm f/2AL	49mm
FA 43mm f/1.9Limited	49mm
FA 50mm f/1.4	49mm
FA 77mm f/1.8Limited	49mm
FA J 18-35mm f/4-5.6AL	67mm
FA 20-35mm f/4AL	58mm
FA J 28-80mm f/3.5-5.6AL	58mm
FA 28-105mm f/3.2-4.5AL (IF)	58mm
FA J 75-300mm f/4.5-5.8AL	58mm

Note: Using a Circular Polarizing Filter

- * In the case of the FA 77mm f/1.8 Limited lens, attaching certain discontinued circular polarizing filters (including the PENTAX Type-A Circular Polarizing Filter) prevents the built-in hood from being pulled out.
- * With an autofocus camera, use a circular polarizing filter instead of a polarizing filter. A polarizing filter affects the accuracy of the autofocus and exposure.

Note: Attaching a Specialized Hood
If the PENTAX Type-A Circular Polarizing Filter (discontinued) is attached to the FA 28-105mm f/3.2-4.5AL (IF) lens, you cannot attach the specialized lens hood since it hits the filter's outer edge. Also, attaching a non-PENTAX circular polarizing filter may still prevent the specialized hood from being attached.

PENTAX Circular Polarizing Filters
(Both discontinued)

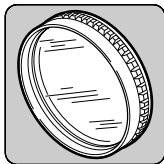

Type A

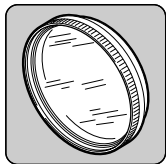

Type B

* Type A is thicker than Type B.

With the built-in flash

Use the built-in flash for subjects at least 0.7 meter away. If the subject is closer than 0.7 meter, overexposure may result.

The built-in flash can usually be used with a lens as long as the |⚡| symbol does not blink in the camera as a warning.

However, with certain lenses vignetting may still occur even if there is no blinking symbol warning. It is also possible for a lens to trigger the blinking symbol warning, but still be used with no problem.

For details, see the built-in flash compatibility table on page 31.

With the **istD*, the blinking |⚡| symbol warning does not appear in the camera even if the lens is unsuitable for the built-in flash. To find out whether the lens is suitable with the **istD*'s built-in flash, see the camera's instruction manual.

When using the built-in flash, remove any lens hood. The lens hood may obstruct the built-in flash.

- * The FA 43mm f/1.9 Limited lens is compatible with the built-in flash even with the lens hood attached.

With an external flash

If you use an external flash, you can use the lens with the lens hood attached. For details, see the external flash's instruction manual.

With the AF500FTZ flash

If the AF500FTZ flash is used with an FA lens shorter than 24mm, the flash does not show a blinking focal length display as a warning.

Compatibility with Built-in Flash

FA and FA J lenses other than the following can be used with the built-in flash with no problems.

Lens	K series	<i>*istD</i> series	<i>*ist</i> MZ series ^{*1}	MZ-S	Z series
FA* 600mm f/4ED (IF)	×	×	×	×	×
FA J 18-35mm f/4-5.6AL	○	△ ^{*2}	△ ^{*3}	△ ^{*4}	△ ^{*3}
FA 20-35mm f/4AL	○	○	△ ^{*5}	△ ^{*6}	△ ^{*5}
FA J 28-80mm f/3.5-5.6AL	○	○	△ ^{*7}	○	△ ^{*8}
FA 28-105mm f/4-5.6 (IF)	○	○	△ ^{*9}	○	△ ^{*9}

*1: Except the MZ-S.

*2: Vignetting may occur if the focal length is 18mm and the subject is closer than 1 meter.

*3: Vignetting occurs at the 18-28mm focal lengths.

*4: Vignetting occurs if the focal length is 18-24mm and the subject is closer than 1.5 meter.

*5: Vignetting occurs at the 20-28mm focal lengths.

*6: Vignetting occurs at the 20-24mm focal lengths.

*7: Although a warning is displayed, vignetting does not occur.

*8: Vignetting occurs at the 28-35mm focal lengths.

*9: Vignetting occurs at the 28-40mm focal lengths.

The soft cases have a case designation as shown in the Lens Case Compatibility Table on the right.

- * A dedicated soft case is provided with FA Limited series lenses.

Lens Case Compatibility Table

Lens	Compatible Case
FA 31mm f/1.8AL Limited	Dedicated case
FA 35mm f/2AL	S80-80
FA 43mm f/1.9Limited	Dedicated case
FA 50mm f/1.4	S70-70
FA 77mm f/1.8Limited	Dedicated case
FA* 600mm f/4ED (IF)	Dedicated case
FA J 18-35mm f/4-5.6AL	S90-100
FA 20-35mm f/4AL	S90-100
FA J 28-80mm f/3.5-5.6AL	S90-100
FA 28-105mm f/3.2-4.5AL (IF)	S90-100
FA J 75-300mm f/4.5-5.8AL	S90-140

*AL: Lens with an aspherical element.

ED: Lens using an Extra-low Dispersion glass.

IF: Lens with internal focusing.

Lens	Construction	Minimum Aperture [F]	Angle of View (Diagonal extent)
FA 31mm f/1.8AL Limited	9 elements in 7 groups	22	70°
FA 35mm f/2AL	6 elements in 5 groups	22	63°
FA 43mm f/1.9Limited	7 elements in 6 groups	22	53°
FA 50mm f/1.4	7 elements in 6 groups	22	47°
FA 77mm f/1.8Limited	7 elements in 6 groups	22	31.5°
FA* 600mm f/4ED (IF)	9 elements in 7 groups	32	4.1°
FA J 18-35mm f/4-5.6AL	12 elements in 10 groups	22-32	100°-63°
FA 20-35mm f/4AL	10 elements in 8 groups	22	94°-63°
FA J 28-80mm f/3.5-5.6AL	8 elements in 8 groups	22-38	75°-30.5°
FA 28-105mm f/3.2-4.5AL (IF)	12 elements in 11 groups	22-32	75°-23.5°
FA J 75-300mm f/4.5-5.8AL	12 elements in 10 groups	32-38	32°-8.2°

FA J lenses do not have an aperture ring. The aperture is controlled at the A [Auto] position.

† Includes tripod mount.

‡ Figures in () indicate the thread diameter of the front ring of Filter.

Min. Focusing Distance [m]	Max. Magnification [x]	Max. Diameter×Length [ømm×mm]	Weight [g]		Filter [mm]
			Lens only	Lens + Hood	
0.3	0.16	65×68.5	345	–	58
0.3	0.17	64×44.5	195	215	49
0.45	0.12	64×27	155	165	49
0.45	0.15	65×37	220	–	49
0.7	0.14	64×48	270	–	49
5.0	0.13	176×457	7,000†	–	43(150)‡
0.28	0.18	72×68.5	190	217	67
0.3	0.16	69.5×68	245	275	58
0.4	0.25	63×67	180	197	58
0.5	0.19	66×65.5	255	280	58
1.3	0.3	68.5×116	385	425	58

This device complies with Part 15 of the FCC Rules. Operation is subject to the following two conditions : (1) This device may not cause harmful interference, and (2) this device must accept any interference received, including interference that may cause undesired operation.

Changes or modifications not approved by the party responsible for compliance could void the user's authority to operate the equipment.

This equipment has been tested and found to comply with the limits for a Class B digital device, pursuant to part 15 of the FCC Rules. These limits are designed to provide reasonable protection against harmful interference in a residential installation. This equipment generates, uses and can radiate radio frequency energy and, if not installed and used in accordance with the instructions, may cause harmful interference to radio communications. However, there is no guarantee that interference will not occur in a particular installation. If this equipment does cause harmful interference to radio or television reception, which

can be determined by turning the equipment off and on, the user is encouraged to try to correct the interference by one or more of the following measures:

- Reorient or relocate the receiving antenna.

Increase the distance between the equipment and receiver.

Connect the equipment to an outlet on a circuit different from that to which the receiver is connected.

* Consult the dealer or an experienced radio/ TV technician for help.

For customers in Canada

This Class B digital apparatus complies with Canadian ICES-003.

Cet appareil numérique de la classe B est conforme à la norme NMB-003 du Canada.

HOYA CORPORATION

PENTAX Imaging Systems Division

2-36-9, Maeno-cho, Itabashi-ku, Tokyo 174-8639, JAPAN (<http://www.pentax.jp>)

PENTAX Europe GmbH

Julius-Vosseler-Strasse 104, 22527 Hamburg, GERMANY

(European Headquarters)

(HQ - <http://www.pentaxeurope.com>) (Germany - <http://www.pentax.de>)

PENTAX U.K. Limited

PENTAX House, Heron Drive, Langley, Slough, Berks SL3 8PN, U.K. (<http://www.pentax.uk>)

PENTAX France S.A.S.

112 Quai de Bezons, B.P. 204, 95106 Argenteuil Cedex, FRANCE (<http://www.pentax.fr>)

PENTAX Italia S.r.l.

Via Dione Cassio, 15, 20138 Milano, ITALY (<http://www.pentaxitalia.it>)

PENTAX (Schweiz) AG

Widenholzstrasse 1, 8304 Wallisellen, Postfach 367 8305 Dietlikon, SWITZERLAND

(<http://www.pentax.ch>)

PENTAX Europe GmbH (Tyskland) Filial Sverige

Box 650, 75127 Uppsala, SWEDEN (<http://www.pentax.se>)

PENTAX Imaging Company

A Division of PENTAX of America, Inc.

(Headquarters)

600 12th Street, Suite 300 Golden, Colorado 80401, U.S.A.

(PENTAX Service Department)

12000 Zuni Street, Suite 100B Westminster, Colorado 80234, U.S.A. (<http://www.pentaximaging.com>)

PENTAX Canada Inc.

1770 Argentia Road Mississauga, Ontario L5N 3S7, CANADA (<http://www.pentax.ca>)

PENTAX Trading

23D, Jun Yao International Plaza, 789 Zhaoyiabang Road, Xu Hui District, Shanghai, 200032 CHINA

(SHANGHAI) Limited

(<http://www.pentax.com.cn>)



The CE Mark is a Directive conformity mark of the European Union.

☆Specifications and external dimensions are subject to change without notice.